

HSF RoHS

REV	ECN NO	DESCRIPTION	DATE	NAME
A		NEW		

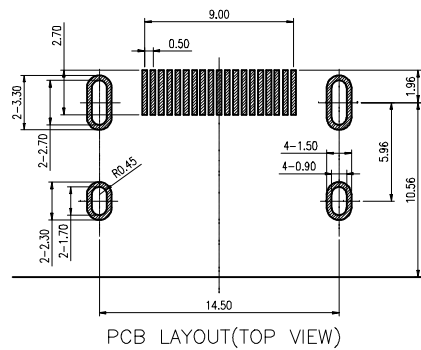
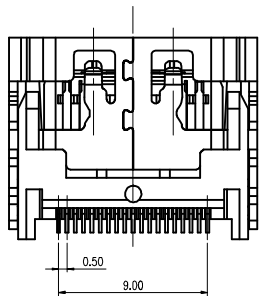
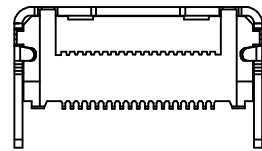
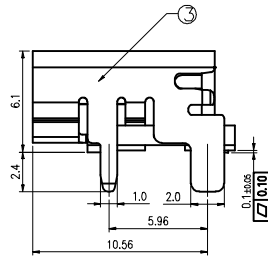
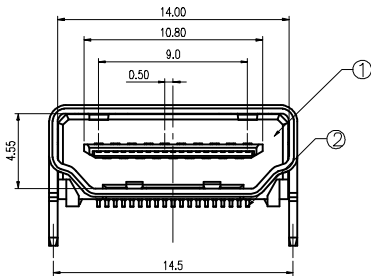
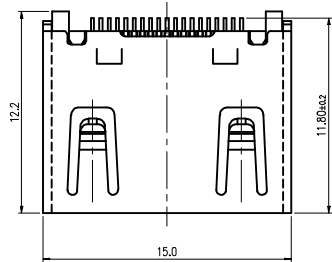

NOTE:

- Material:
 - Housing: Thermoplastics,UL94V-0; COLOR: BLACK
 - Contact: Copper Alloy
 - Shell: SPCC
- FINISH:
 - Contact: Au Plated on Contact Arca, Matte Tin Plated on Solder Tails, Nickel Underplating Over All.
 - Shell: Nickel Underplating Over All.
- Specification:
 - Electrical:
 - Insulation Resistance(EIA-364-21): 100MΩ Min. at 500V/DC for 1Minute.
 - Contact Resistance(EIA-364-06): 10 mΩ Max.
 - Dielectric Withstanding Voltage(EIA-364-20): No discharge, flashover or breakdown at 500V/AC 1Minute

Ordering Information

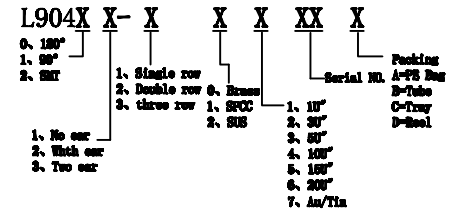

3	SHELL	1	SPCC	PLATED:Cu/Ni
2	CONTACT	19	COPPER ALLOY	PLATED:Ni/Au/Matte Tin
1	HOUSING	1	LCP UL94 V-0	BLACK
NO.	ITEM	Q'TY	MATERIAL	FINISH

LDCONN 东莞连大精密制品有限公司

大 DongGuan LianDa Precision Products Co., LTD

STANDARD TOLERANCE (EXCEPT SPECIFIED)			
LINER		ANGLES	
.0	±0.30	0.°	±3°
.00	±0.25	.0°	±2°
.000	±0.15	.00°	±1°

TITLE	HMIA/P-X SMT No ear with shrapnel	DRAWN BY	Lujunhui	18.11.07
PART NO	L90421-11XXXD	CHECKED BY		
DRAWING NO		APPROVED BY		
SCALE	1:1	UNIT	mm	PAGE 1/1
				SIZE A4